

STAFFE DI FISSAGGIO MOLLE A GAS

| CODICE | DESCRIZIONE | ATTACCO |
|------------|---|---------|
| JR20012001 | Kit attacchi in alluminio anodizzato nero | A3 - B3 |

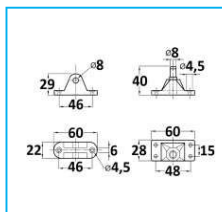

| CODICE | DESCRIZIONE | ATTACCO |
|------------|--|---------|
| JR20012002 | Attacco parte femmina in alluminio anodizzato nero | A3 - B3 |

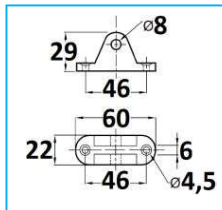

| CODICE | DESCRIZIONE | ATTACCO |
|------------|--|---------|
| JR20012003 | Attacco parte maschio in alluminio anodizzato nero | A3 - B3 |

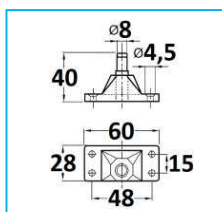

| CODICE | DESCRIZIONE | ATTACCO |
|------------|---|-----------|
| JR20013001 | Kit attacchi in alluminio anodizzato nero | A15 - B15 |

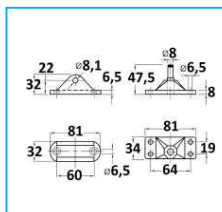

| CODICE | DESCRIZIONE | ATTACCO |
|------------|--|-----------|
| JR20013002 | Attacco parte femmina in alluminio anodizzato nero | A15 - B15 |

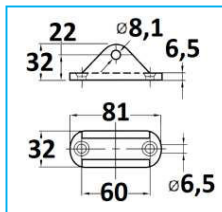

| CODICE | DESCRIZIONE | ATTACCO |
|------------|--|-----------|
| JR20013003 | Attacco parte maschio in alluminio anodizzato nero | A15 - B15 |

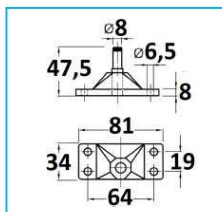
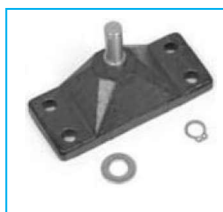

NB: LE MISURE SONO IN "mm".

STAFFE DI FISSAGGIO MOLLE A GAS

| CODICE | DESCRIZIONE | ATTACCO |
|------------|------------------------------------|---------|
| JR20014001 | Staffe di fissaggio carico pesante | Ø 9,9 |

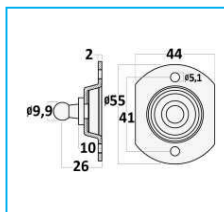

| CODICE | DESCRIZIONE | ATTACCO |
|------------|------------------------------------|---------|
| JR20014002 | Staffe di fissaggio carico pesante | Ø 8 |

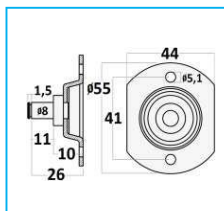

| CODICE | DESCRIZIONE | ATTACCO |
|------------|------------------------------------|---------|
| JR20014003 | Staffe di fissaggio carico pesante | Ø 9,9 |

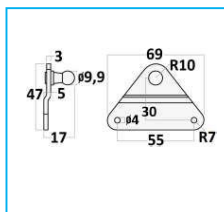

| CODICE | DESCRIZIONE | ATTACCO |
|------------|------------------------------------|---------|
| JR20014004 | Staffe di fissaggio carico pesante | Ø 8 |

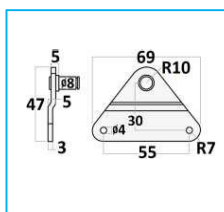

Procuriamo anche staffe di fissaggio a carico leggero.

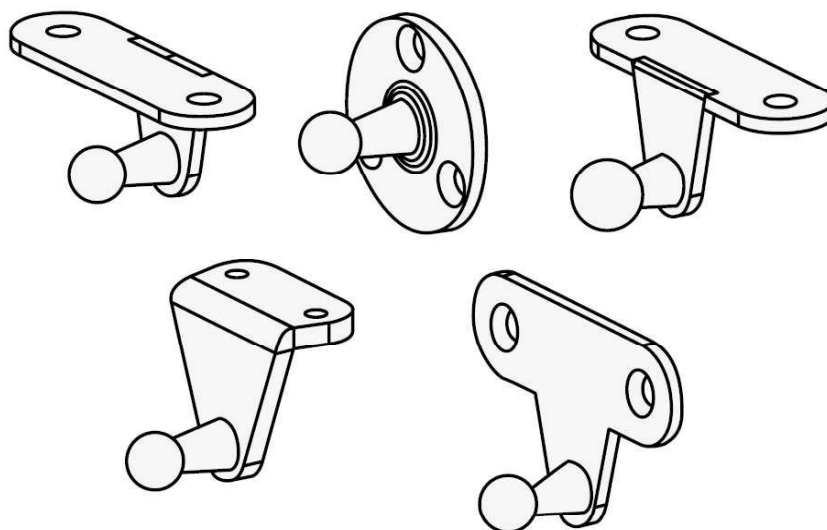

NB: LE MISURE SONO IN "mm".